

REDALP DH >>> SREW TORQUE LIST

<p>Rear axle nut</p>	 <p>20 Nm</p>
<p>Chain link shaft M6 and pushrod screw titanium M6</p> <p>10 Nm Loctite blue</p> <p>Do not tight from this side!</p>	 <p>10 Nm</p>

<p>Upper frame M6 alu</p>	 <p>8 Nm 4x</p>
<p>Rear suspension front shaft M10x1</p>	 <p>10 Nm</p>
<p>Suspension link M8 titanium Pivot shaft M7</p>	 <p>20 Nm</p> <p>20 Nm</p> <p>10 Nm from nut side !</p>
<p>Pushrod rear suspension on swing arm</p>	 <p>20 Nm</p>

**Pivot shaft
screw M5
titanium**

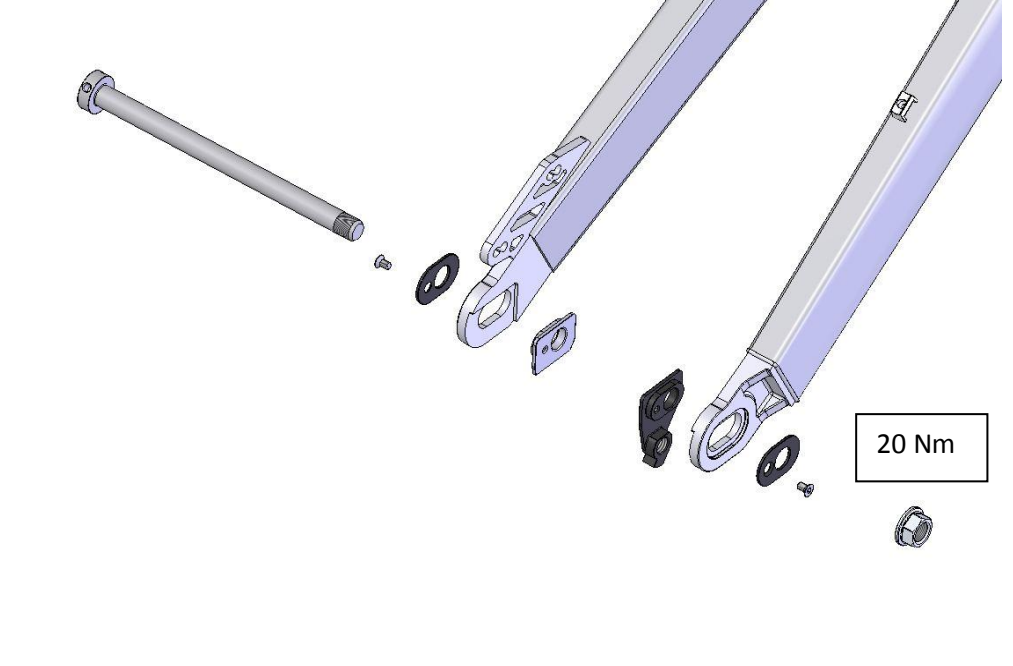
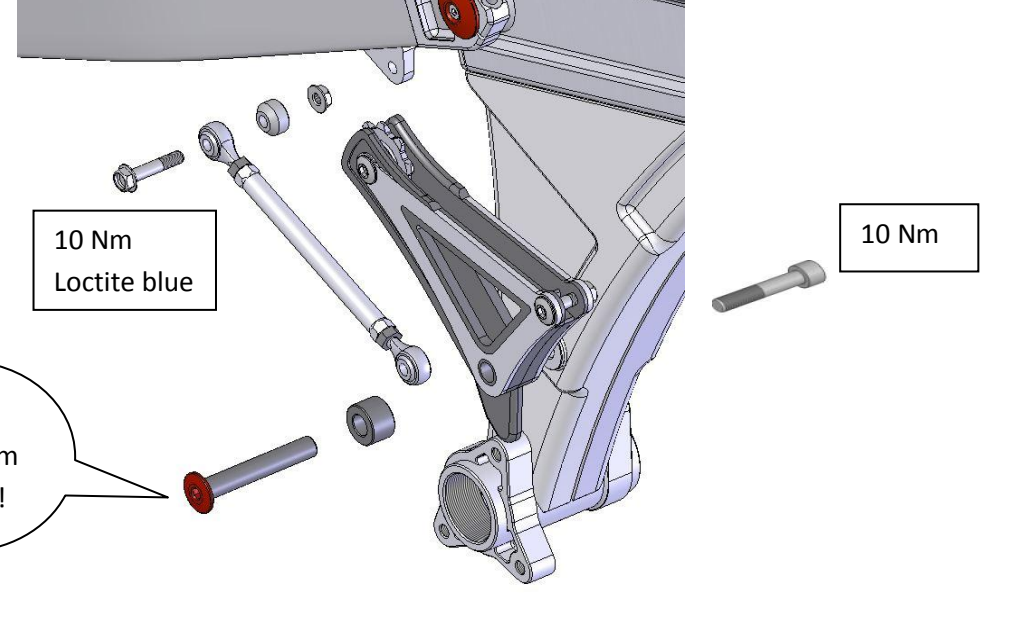
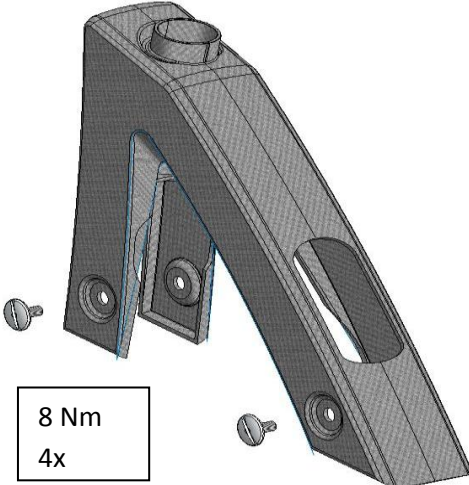
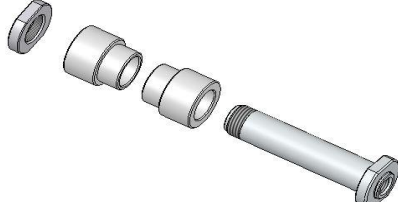
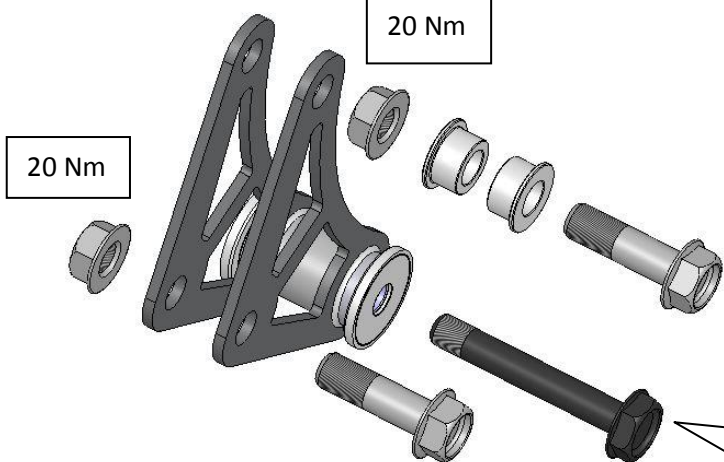
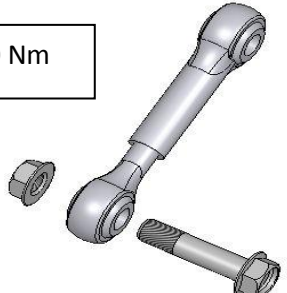
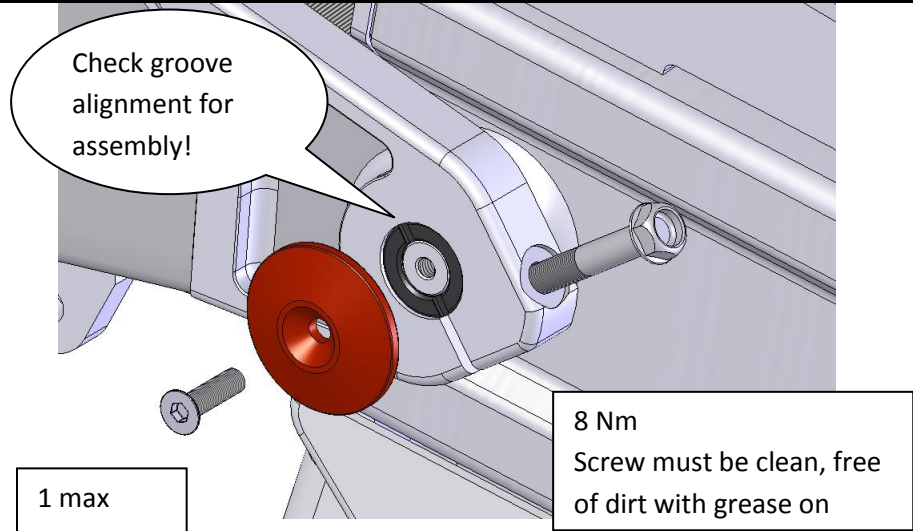

Chain guide M6



**Jockey wheel
and push M6
titanium**

